

3. (1)

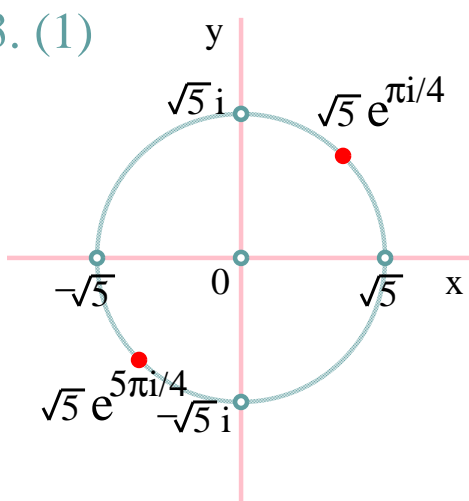

(2)

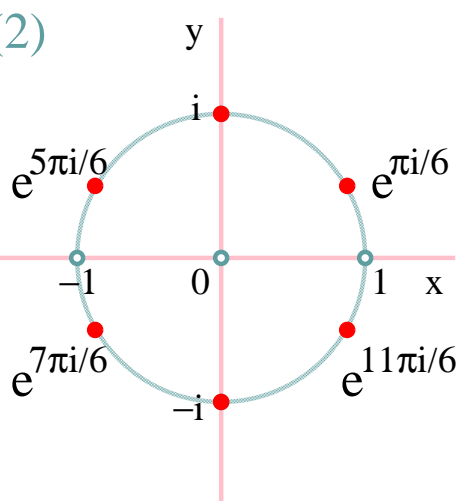

(3)

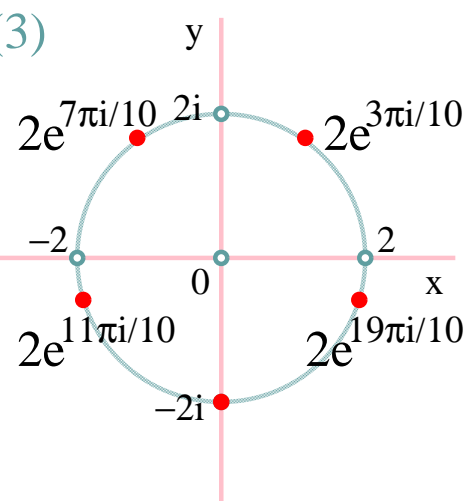

4.

(1)

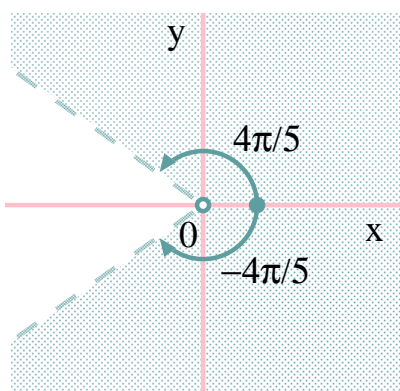

(2)

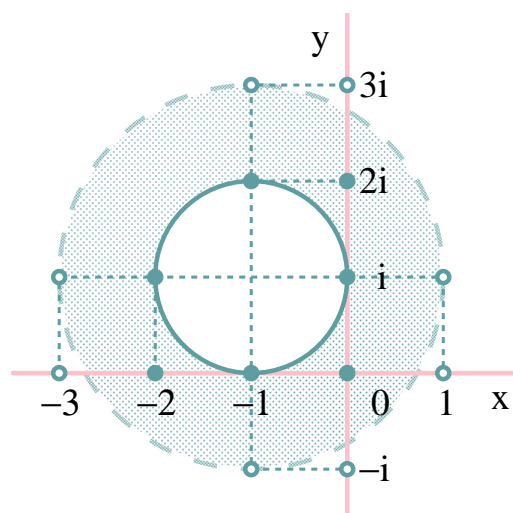

(3)

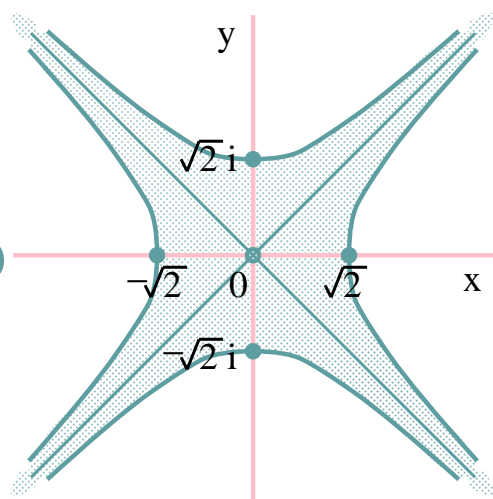

(4)

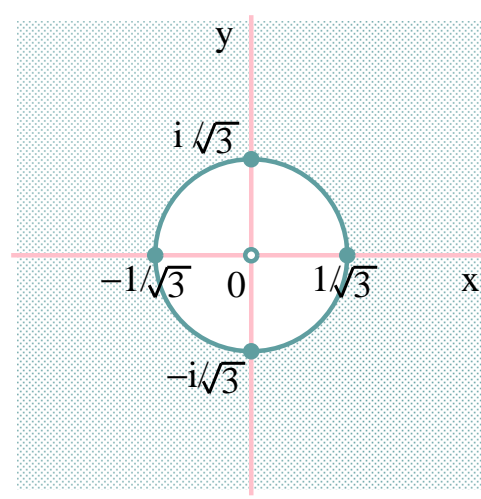

4.

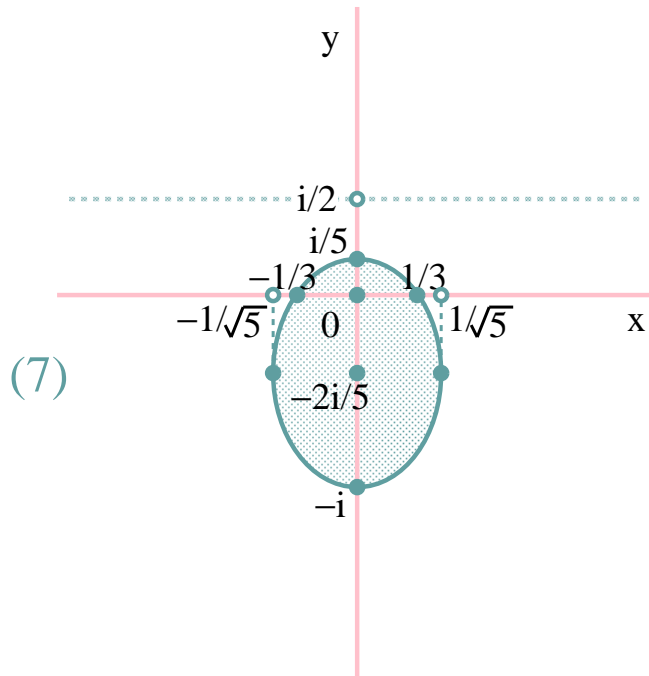
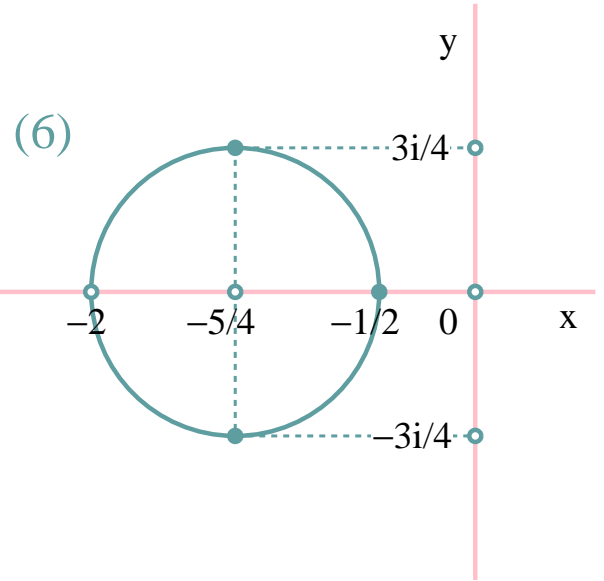
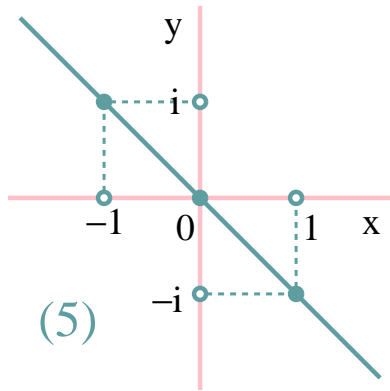

5. (2)

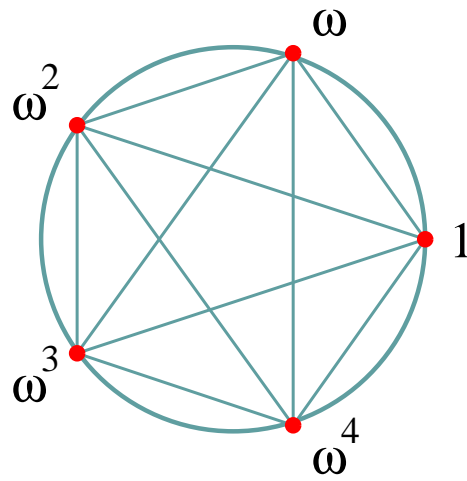

7.

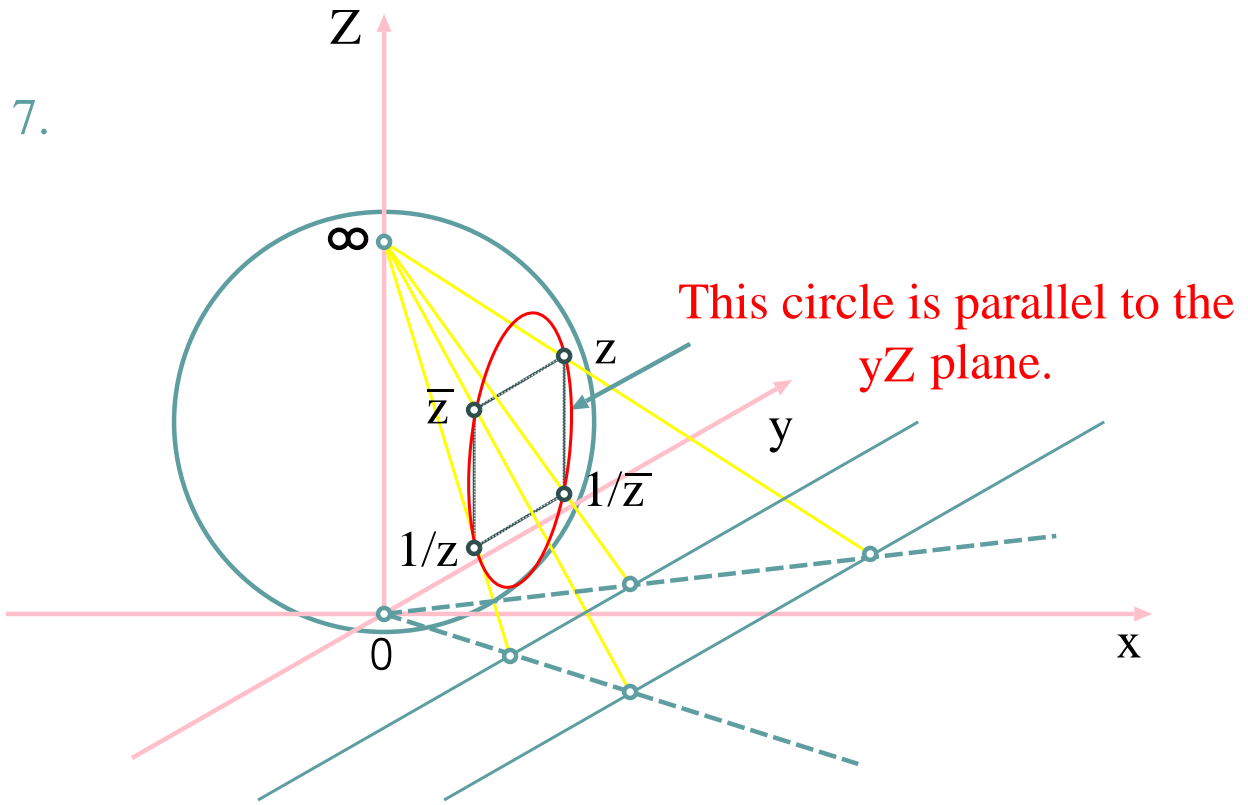

8.

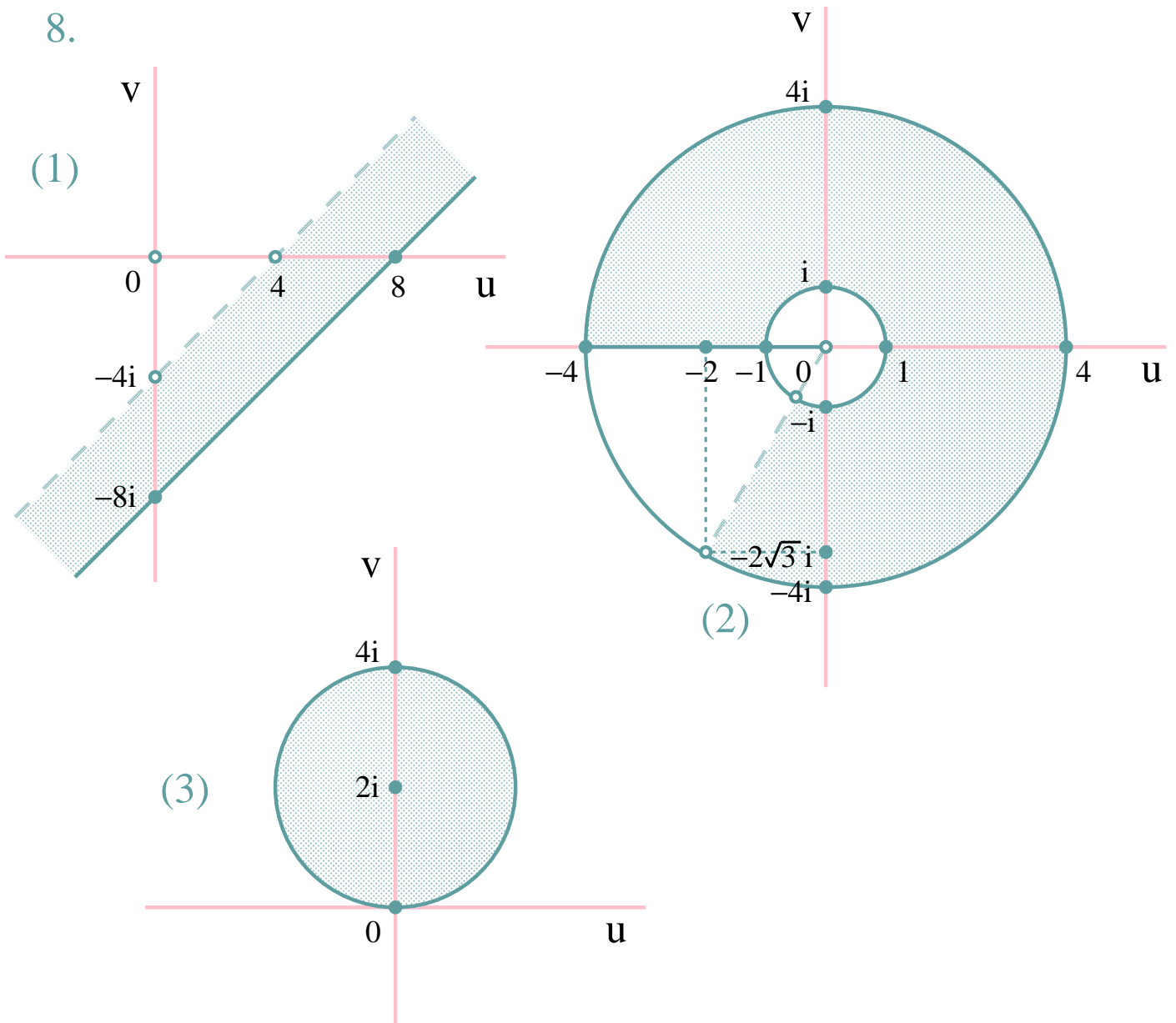

19. (1)

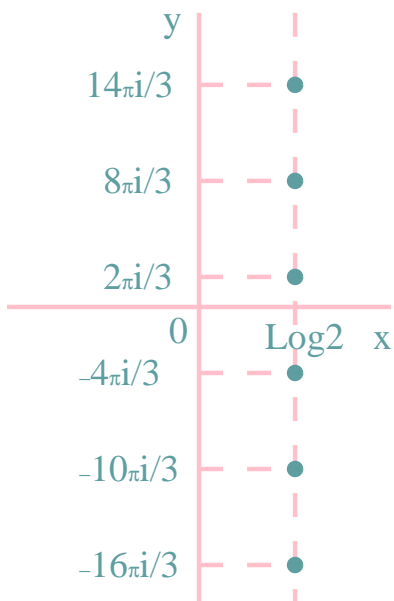

(2)

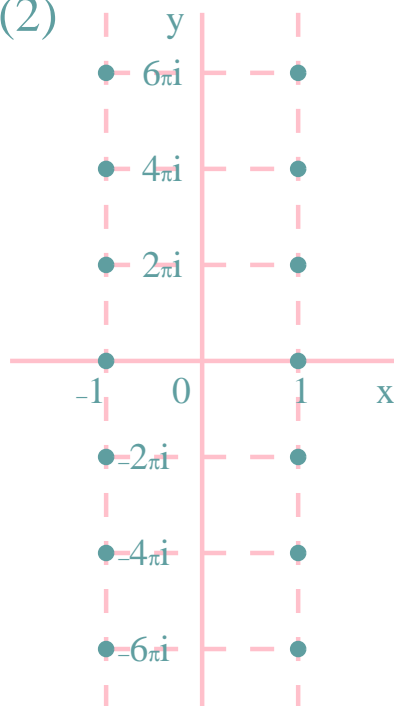

(3)

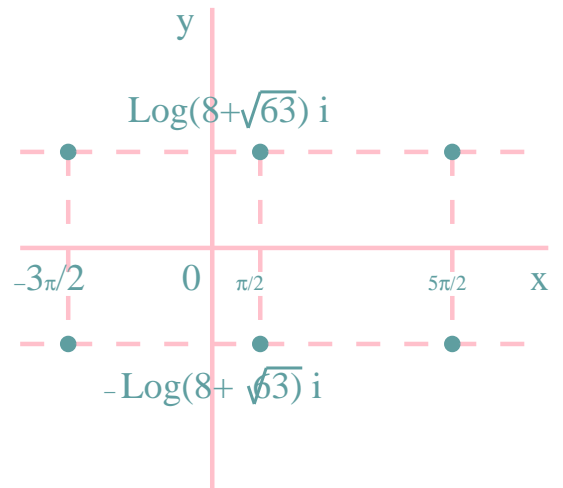

29.

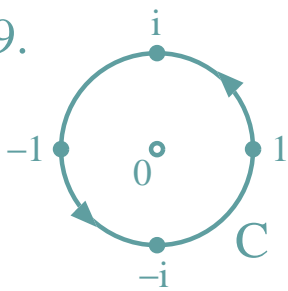

30.

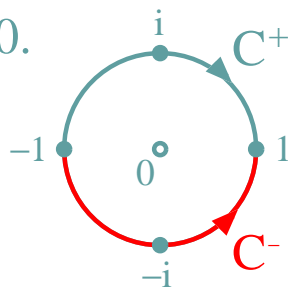

31.

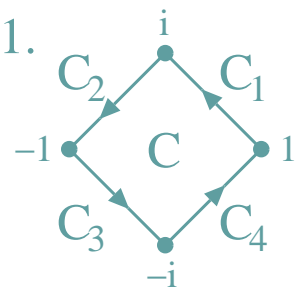

33.(2)(3)

32.

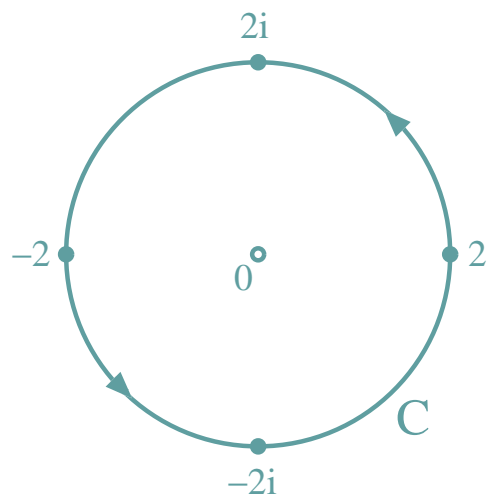
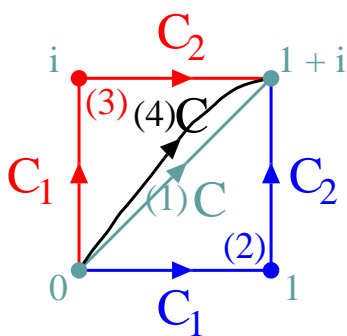

33.(1)

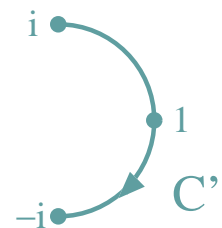

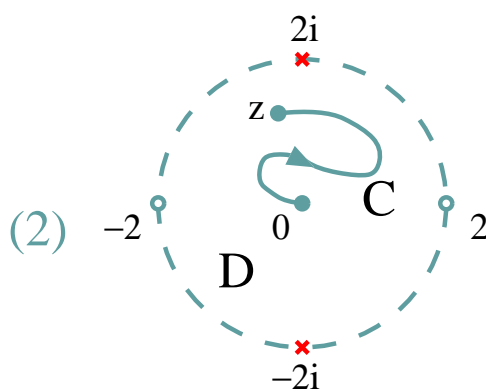
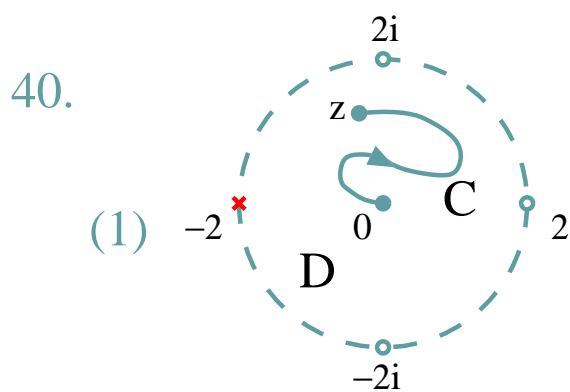
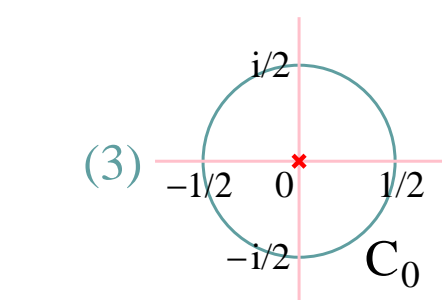
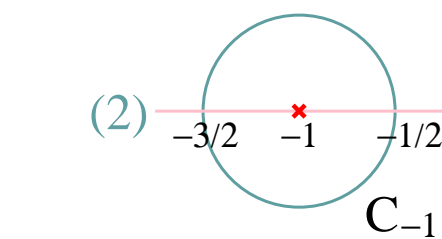
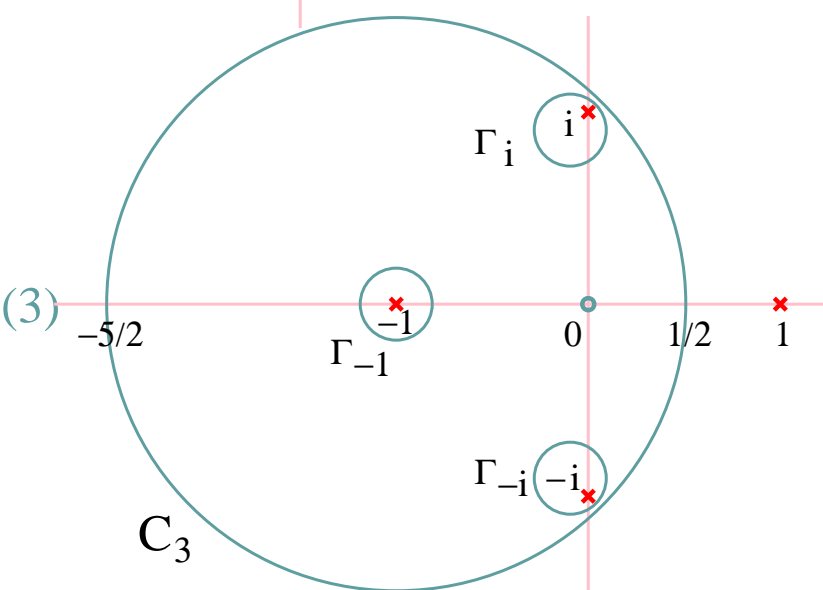
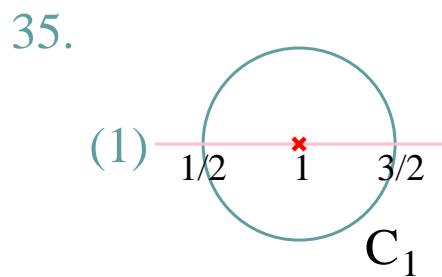
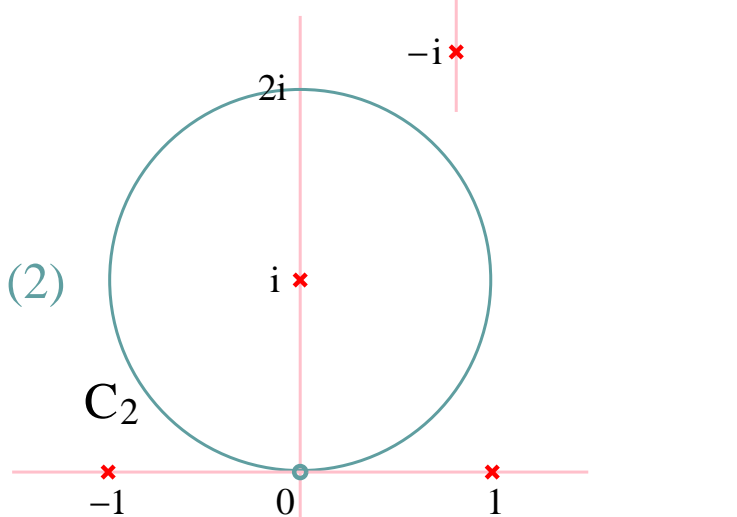
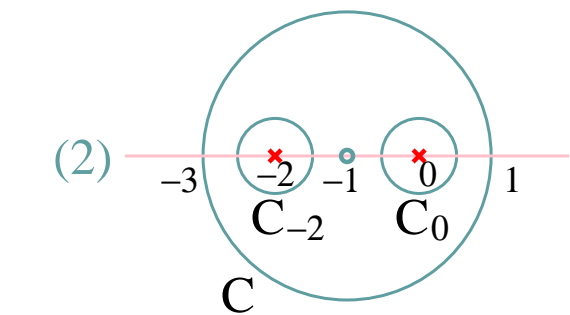
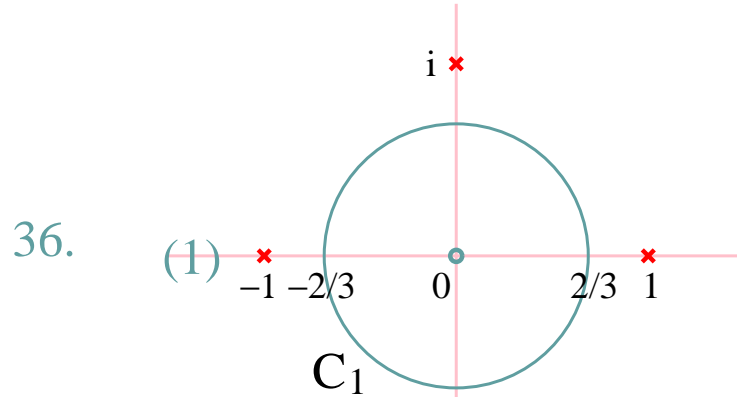
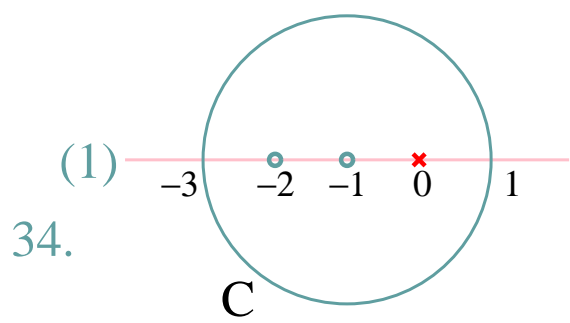

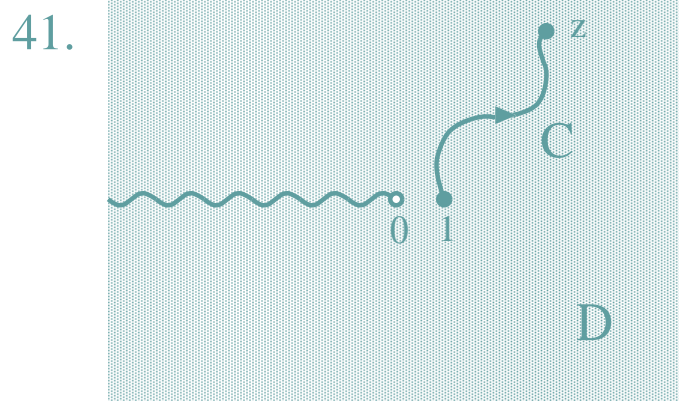
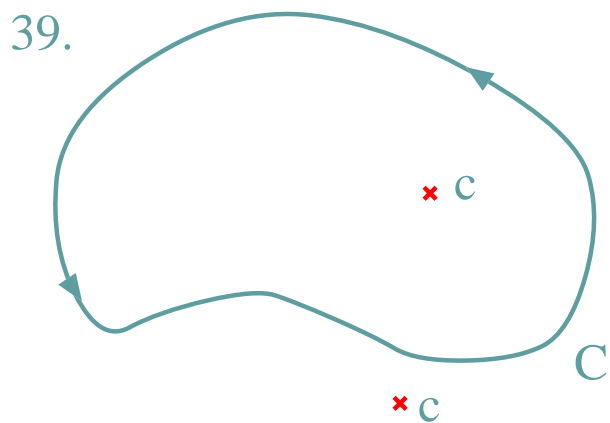
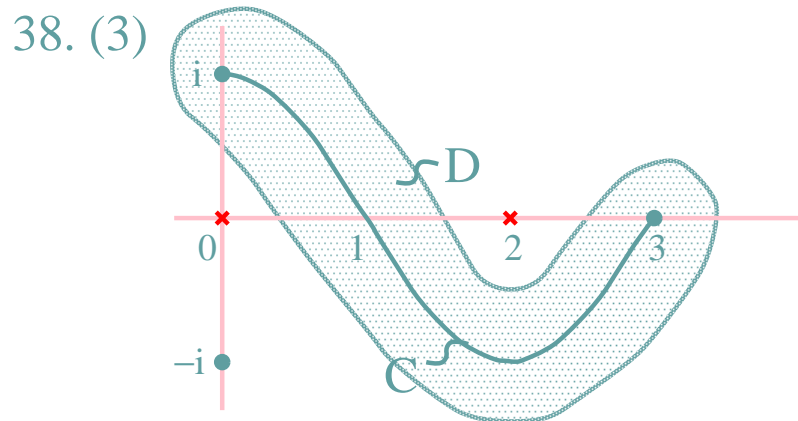
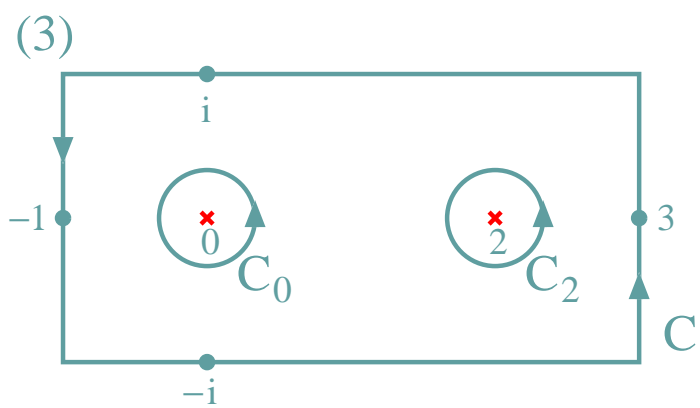
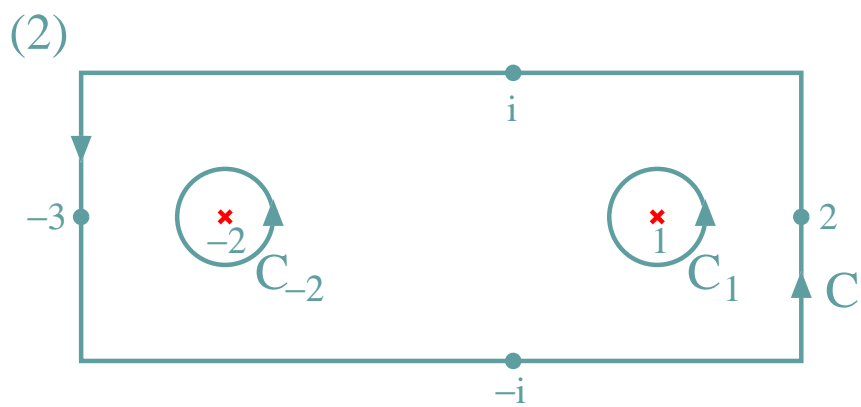
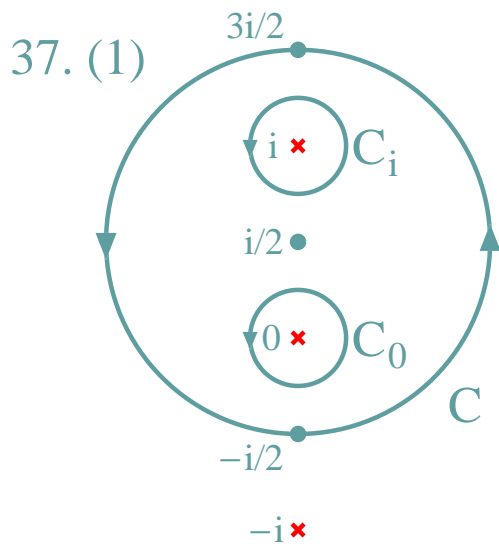

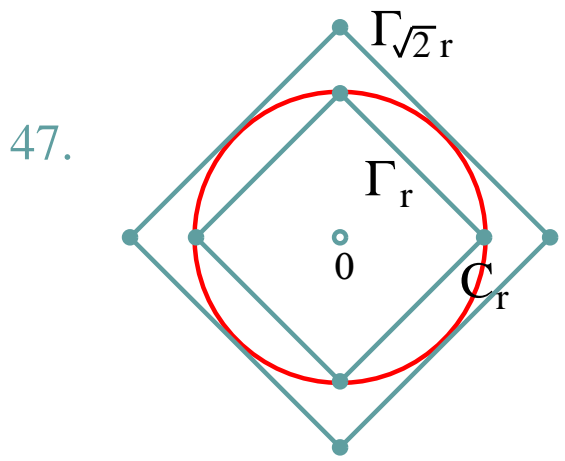
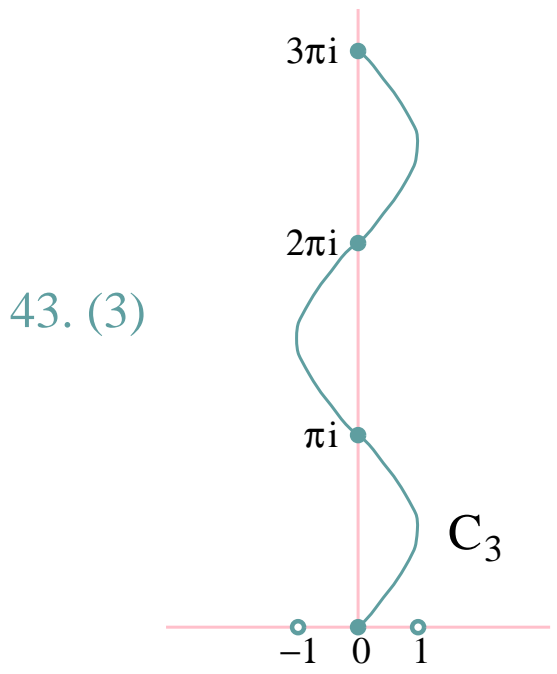
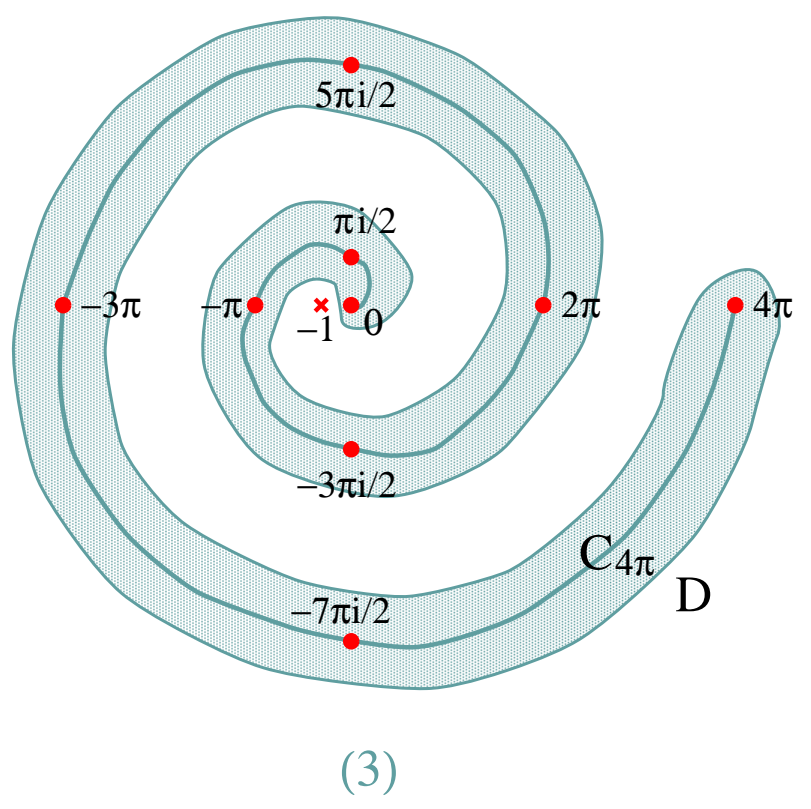
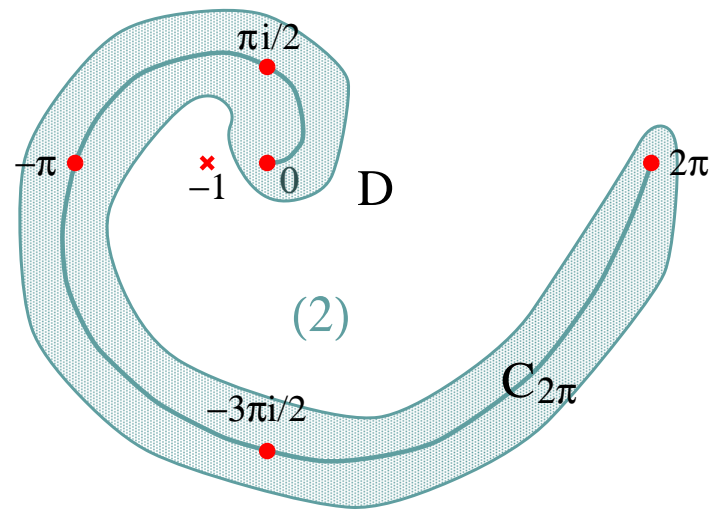
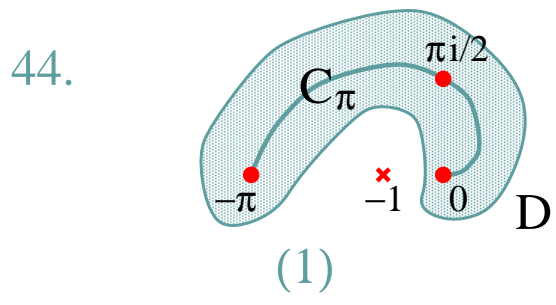
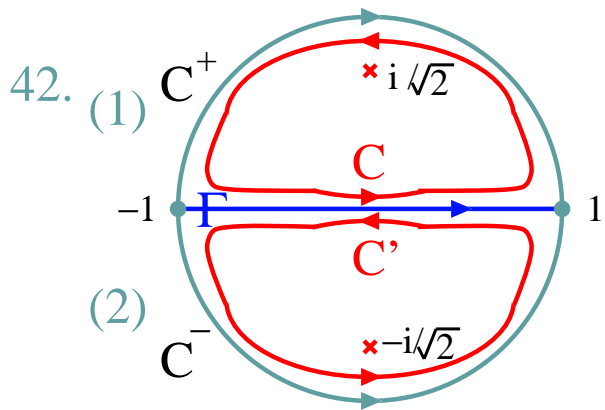

71. (1)(2)

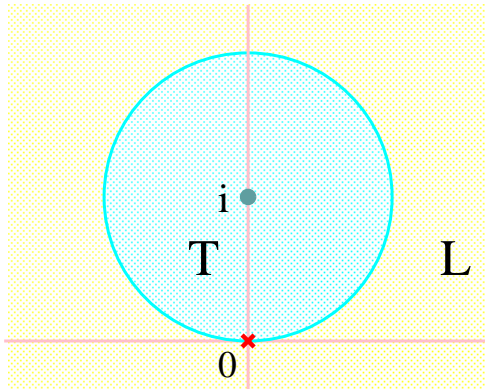

T: Taylor expansion  
L: Laurent expansion

72. (1)

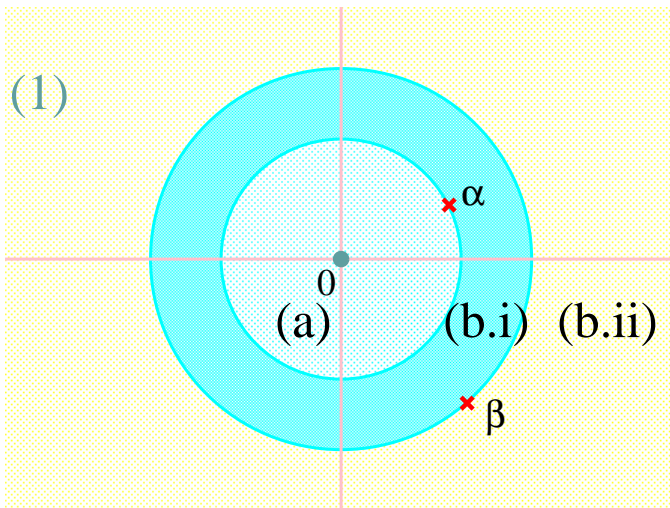

(2)

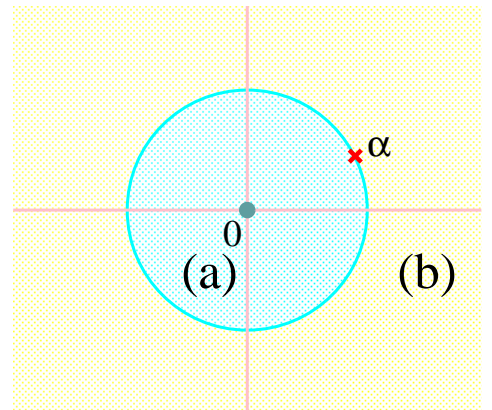

74. (1)

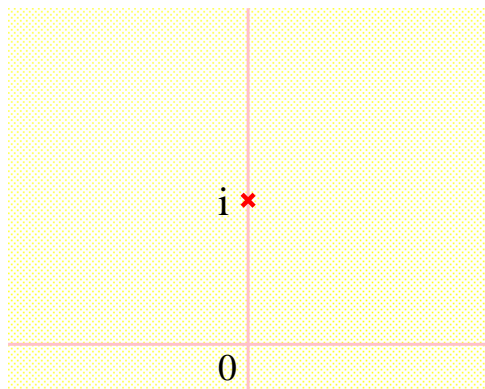



74. (2)

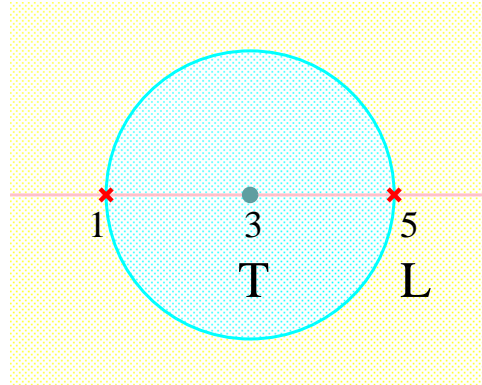

(3)

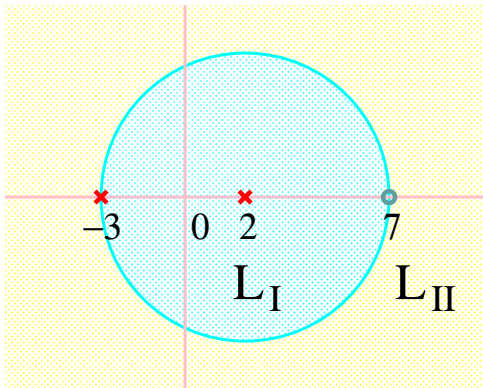

(i)  $z = 2$ : center

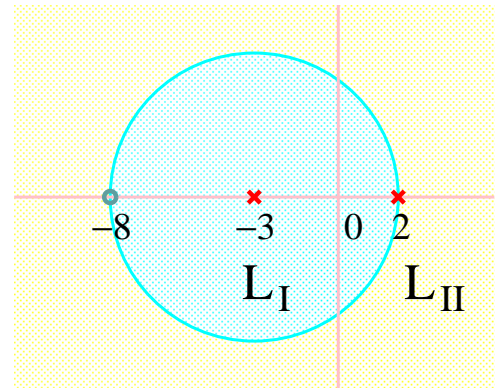

(ii)  $z = -3$ : center

(4)

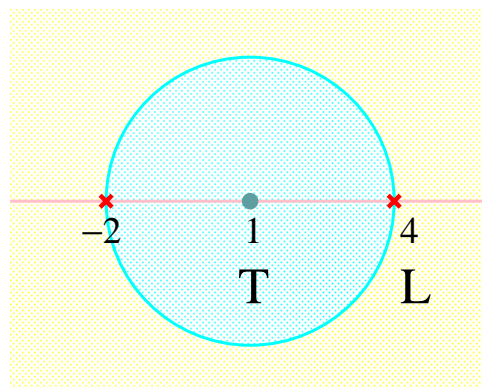

76.(1),(2)

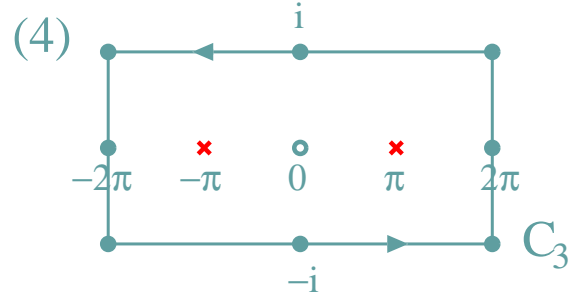
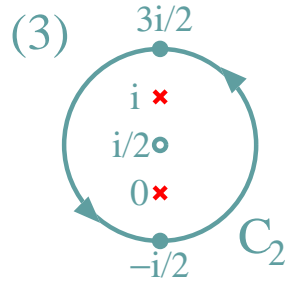
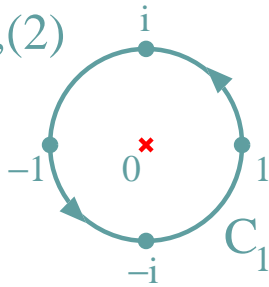

83.(3)

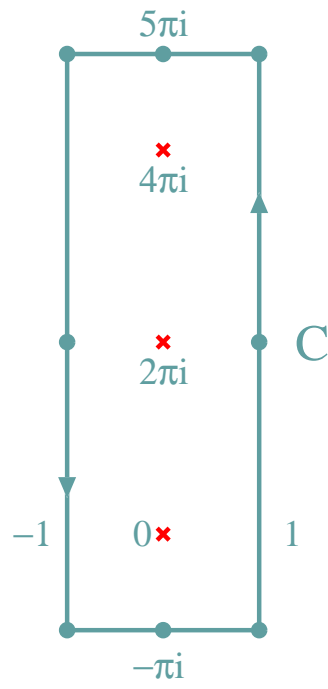

88.

